

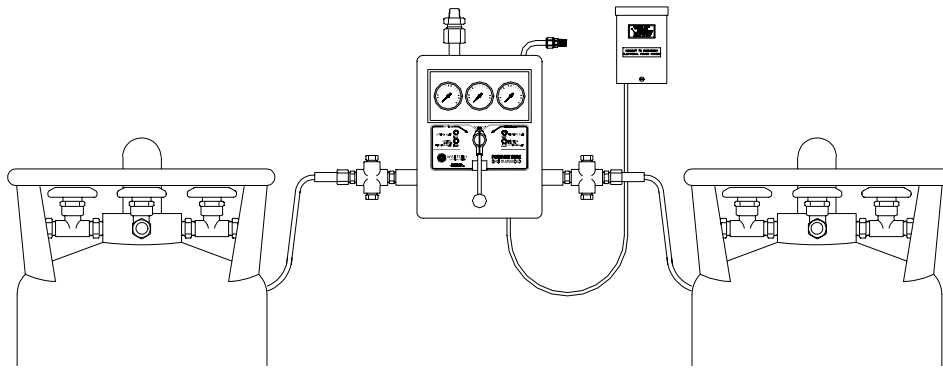

Installation and Operating Instructions For AUTOMATIC CHANGEOVER MANIFOLD LC and LCHP SERIES



INTRODUCTION

Western manifold systems are cleaned, tested and prepared for the indicated gas service and are built following National Fire Protection Association and Compressed Gas Association guidelines. The manifold is specifically designed to regulate and monitor vaporized gas from liquid cylinders with contents pressures between 125 - 250 psig and to provide an uninterrupted supply of gas for the specific gas application. The control is designed and built with features providing automatic changeover from the depleted "Service" supply bank to the "Secondary" supply with no loss or drop in delivery pressure. Pressure gauges, alarm signal connections and lights show system status and alert the need to replace depleted cylinders. An economizer control valve is contained within the cabinet to utilize accumulated pressure from the "Secondary" bank preventing the exhausting of useful product into the atmosphere. Features of the automatic systems include an integral adjustable line regulator, 72" cryogenic flexible pigtails with check valves and complete mounting hardware.

CAUTION

Failure to follow the following instructions can result in personal injury or property damage:

- Never permit oil, grease, or other combustible materials to come in contact with cylinders, manifold, and connections. Oil and grease may react and ignite when in contact with some gases — particularly oxygen and nitrous oxide.
- Cylinder valves should always be opened very s-l-o-w-l-y. Heat of recompression may ignite combustible materials.
- Pigtails should never be kinked, twisted, or bent into a radius smaller than 5 inches. Mistreatment may cause the pigtail to burst.
- Do not apply heat. Some materials may react and ignite when in contact with some gases — particularly oxygen and nitrous oxide.
- Cylinders should always be secured with racks, chains, or straps. Unrestrained cylinders may fall over and damage or break off the cylinder valve which may propel the cylinder with great force.
- Carefully read and follow installation and mounting instructions! Manifolds are designed for gas withdrawal from cryogenic liquids. Contact of a cryogenic liquid or cold gas with skin or eyes may cause a freezing injury.
- Oxygen manifolds and cylinders should be grounded. Static discharges and lightning strikes may ignite materials in an oxygen atmosphere, creating a fire or explosive force.
- Welding should not be performed near nitrous oxide piping. Excessive heat may cause the gas to dissociate, creating an explosive force.

WARRANTY

All Western manifolds are warranted against defects in materials and workmanship for the period of one year from date of purchase. See back cover for details of limited warranty.

TABLE OF CONTENTS

GENERAL INSTRUCTIONS	3
CONTROL SECTION INSTALLATION	4
HEADER INSTALLATION	4
PLUMBING	5
HEALTH CARE INSTALLATIONS	5
ELECTRICAL.....	5
REMOTE ALARM HOOKUP	6
INSTALLING PIGTAILS AND ATTACHING CYLINDERS	7
START UP AND CHECKING PROCEDURES.....	7
MANIFOLD OPERATION.....	8
CYLINDER REPLACEMENT & HANDLING	9
LINE DELIVERY PRESSURE ADJUSTMENT.....	10
GENERAL MAINTENANCE	10
TROUBLE-SHOOTING	11
MANIFOLD MAINTENANCE & REPAIR PARTS.....	13
REPLACEMENT PIGTAILS.....	13
INDICATOR LAMP REPLACEMENT PARTS	13
PANEL MOUNT GAUGES.....	13
REGULATORS AND REGULATOR REPAIR KITS.....	13
VALVES AND VALVE REPAIR KITS	13
PRESSURE SWITCH REPLACEMENT PARTS	13
POWER SUPPLY REPLACEMENT PARTS	13
REMOTE ALARMS.....	13
WARRANTY	14

GENERAL INSTRUCTIONS

Manifolds should be installed in accordance with guidelines stated by the National Fire Protection Association, the Compressed Gas Association, OSHA and all applicable local codes. The manifold should not be placed in a location where the temperature will exceed 120°F (49°C) or fall below 0°F (-17°C). A manifold placed in an open location should be protected against weather conditions including rain and heavy moisture. During winter, protect the manifold from ice and snow. In summer, shade the manifold and cylinders from continuous exposure to direct rays of the sun. The manifold should be located in a clean, well ventilated area which is free of oil and combustible materials.

Leave all protective covers in place until their removal is required for installation. The control indicator knob on the manifold control section should be left in the "OFF" position until supply or test cylinders are connected. This precaution will keep moisture and debris from the piping interior, avoiding operational problems.

CAUTION:

- Remove all protective caps prior to assembly. The protective cap may ignite due to heat of recompression in an oxygen system.

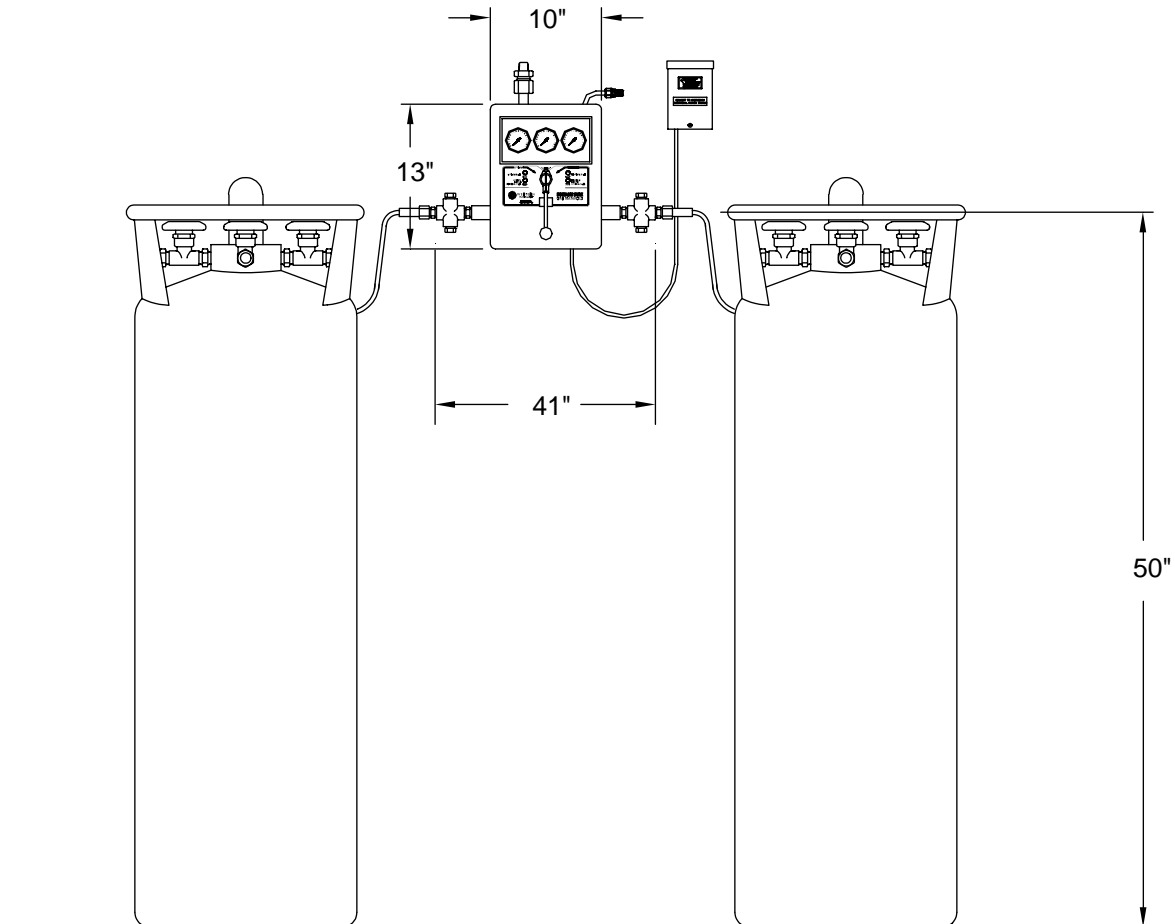

FIGURE 1

CONTROL SECTION INSTALLATION

1. Determine and mark the vertical center line for installation of the manifold control. (Figure 2)
2. Measure from the floor to a point 57" in height* of this vertical line. Using a spirit level, mark a horizontal line at this point extending approximately 10" to the left and 10" to the right of center.

(* — Suggested manifold height. Wall mounting heights may vary from one installation to another depending on available space, cylinder height, etc.)

3. Remove the mounting bracket from the back of the manifold control by removing the nut at the bottom of the bracket. Place the upper edge of the "tee" mounting bracket on the marked horizontal line and centered with the vertical line. Holding the bracket with the slotted extensions away from the wall, mark the locations for three mounting bolts. (Figure 3)
4. Anchor the mounting bracket to the wall. Selection of mounting fasteners will depend upon wall construction. (Figure 3)
5. Secure the manifold control in place by sliding the round retainers on the back of the cabinet into the slots on the bracket. Replace the nut on the bolt which protrudes from the case and tighten lightly. This bolt only stabilizes the bottom of the unit and is not load-bearing. (Figure 4)

NOTE: If using a single bank LC manifold with high pressure reserve cylinders as the right bank, the following modifications to the manifold unit are necessary. (see figure 5)

1. Remove the right side inlet cross and adaptor using a $1\frac{1}{4}$ " hex wrench to stabilize the inlet block and a pipe wrench to grip the adaptor.
2. Remove all debris from the inside of the inlet block. Apply teflon tape or a suitable oxygen safe pipe thread sealant to the male pipe thread on the straight adaptor provided with the high pressure reserve manifold.
3. Install the adaptor in the inlet block using a $1\frac{1}{4}$ " hex wrench to stabilize the inlet block and a $1\frac{3}{8}$ " wrench to grip the adaptor.
4. Secure the manifold control in place as noted in step 5 above.

5. Attach the header to the regulator union on the right side of the manifold control. Using a spirit level, mark the placement of mounting brackets while keeping the header on a horizontal plane.
6. Remove the U-bolt assemblies from the header mounting brackets. Position the brackets so that the top of the bracket is aligned with the bottom of the headers and is centered between the cylinder connections. The end bracket should be placed as close to the last cylinder as possible to provide the most support and stability.
7. Mark the mounting hole and install fasteners suitable for the type of wall construction.
8. Fit the U-bolt over the header piping and tighten the two mounting nuts.

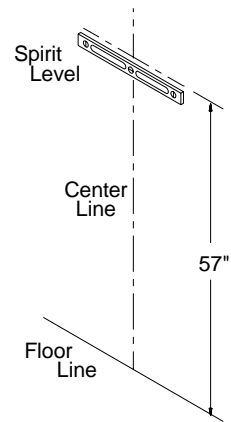

FIGURE 2

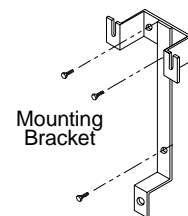

FIGURE 3

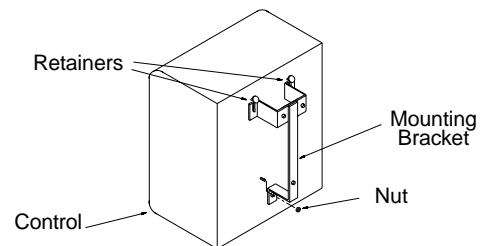

FIGURE 4

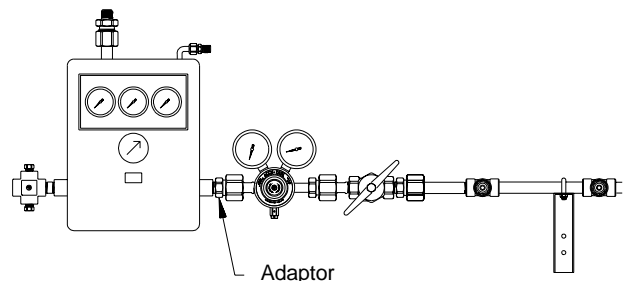

FIGURE 5

PLUMBING

1. A 1/2" NPT male union is supplied with the control and is located at the upper left side of the manifold control. Connect this union to the pipeline system. Sweat joints must be silver soldered. Use BAg series silver solder (DO NOT USE SOFT SOLDER). Heat the entire joint evenly. Apply enough heat favoring heavy sections, so that solder flows freely around the joint leaving no pin holes. (See National Fire Protection Association Pamphlet No. 99). The union provided permits removal of the manifold control for service. (Figure 6)

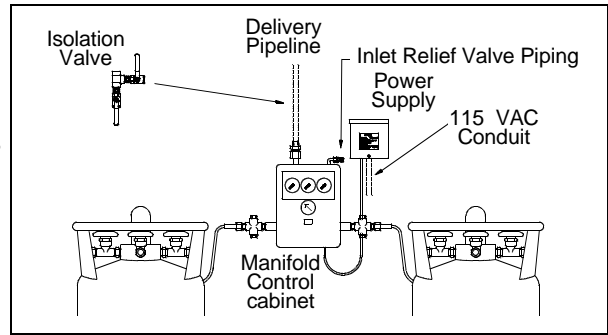

FIGURE 6

2. If the manifold is installed in a closed area, vent piping must be attached to the Inlet relief valves located on the top right of the manifold control. The vent connection is 1/4 NPT male.
3. Installation of a shut-off valve to isolate the pipeline during service to the manifold is recommended.

HEALTH CARE INSTALLATIONS

1. Install LC system per plumbing section.
2. Install the check valves, reserve manifold, pressure switch and dual line assembly per the schematic shown in figure 7.

ELECTRICAL

1. A 24 VAC power supply transformer is furnished with the control unit. Mount the box on the wall with the bottom edge approximately at the top of the control cabinet. The attached control cable terminates in a 4-way plug matching a receptacle on the bottom of the control cabinet. (Figure 6)
2. After mounting the power supply box to the wall, plug the cable into the control cabinet receptacle.
3. One hole on the underside of the power supply box provides access for conduit and connection of 115 VAC power to the black primary leads. Remove 115 VAC power prior to making connections. The other hole on the underside of the power supply transformer box provides access for remote alarm connections.
4. After completing the 115 VAC connections, the power supply should be complete and functional and 115 VAC power can be restored.

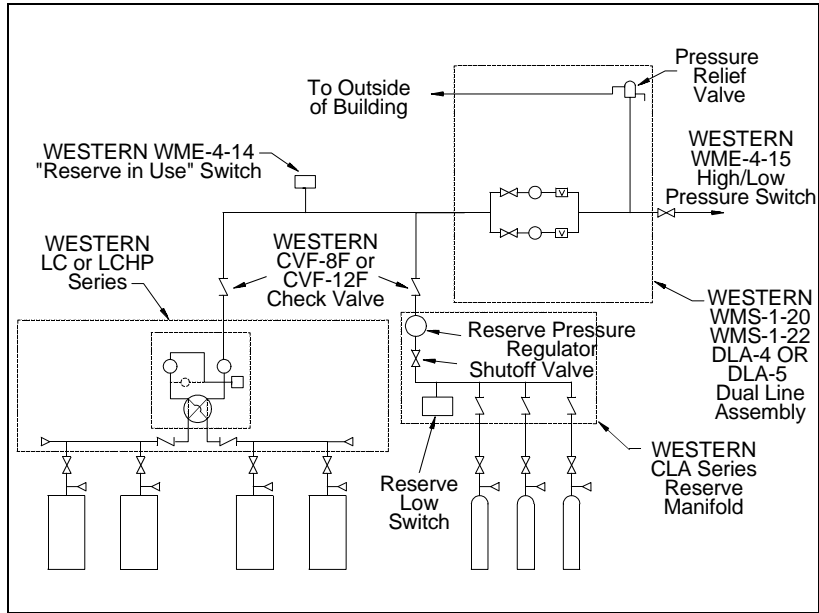

FIGURE 7

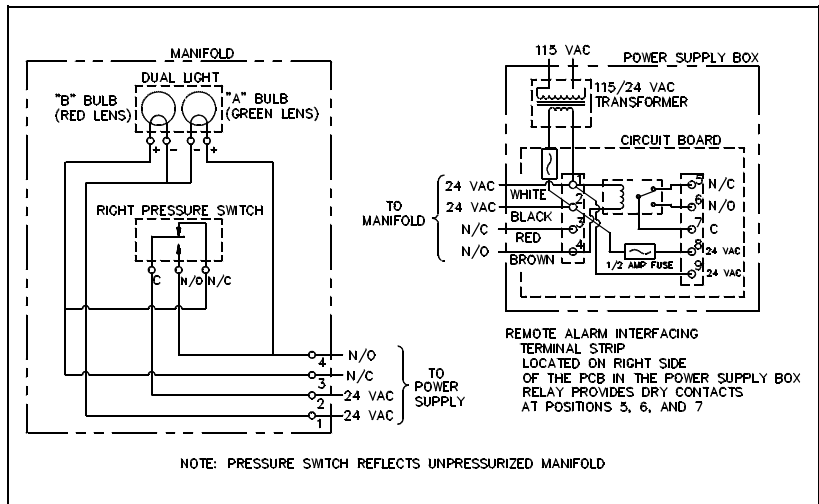

FIGURE 8

5. The manifold wiring schematic is shown in figure 8.

REMOTE ALARM HOOKUP

A five terminal remote alarm terminal strip is on the right side of the circuit board in the power supply box for remote alarm interfacing. The top three terminals on this strip (N/C, N/O, and C) provide dry contacts for remote alarm hookup. Wiring diagrams for remote audio/visual alarms are included with the alarms. Listed below are four different remote alarm configurations. Terminals identified as N/O and N/C have been marked in the un-actuated state.

In some instances the power supply for the remote alarm is normally a part of the electrical contract on proposed constructions and should exist in any furnished hospital. The following procedure should be followed:

1. Two alarm signal wires requiring dry contacts should run to the manifold location.
2. Connect one signal wire to the common (C) terminal and the other signal wire to the normally open (N/O) terminal on the terminal strip on the right side in the power supply box. (Figure 9)

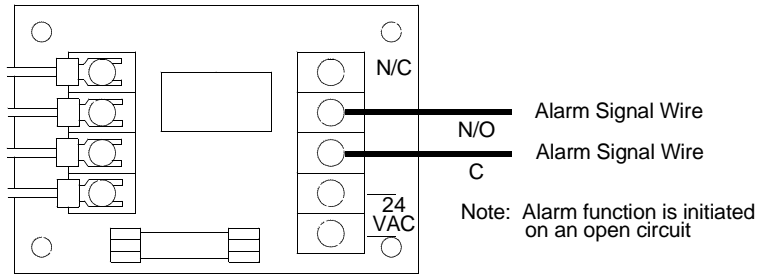

FIGURE 9

If the remote alarm is designed for 24 VAC operation then connect the alarm as follows: (Also see WESTERN'S ALARM section below.)

1. Connect the ground wire from the alarm to one 24 VAC terminal on the right side of the circuit board in the power supply box. (Figure 10)
2. A jumper wire is connected between the other 24 VAC terminal and the common (C) terminal.

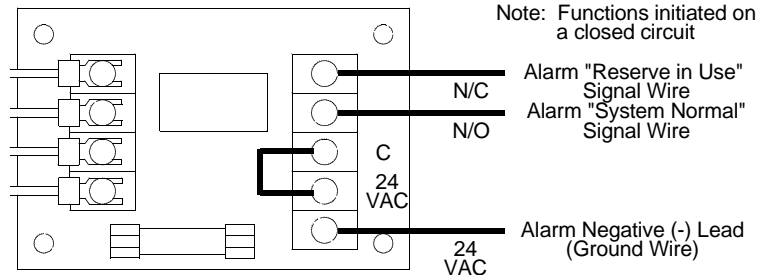

FIGURE 10

3. Connect the "reserve in use" signal wire to the normally closed (N/C) terminal.
4. If a "system normal" signal is also employed, connect that signal wire to the normally open (N/O) terminal.

If the remote alarm is designed for voltages other than 24 VAC then connect the alarm as follows:

1. Connect the ground wire from the alarm to the negative (-) connection at the power source. (Figure 11)
2. There should be NO connections to the 24 VAC terminals on the right side of the circuit board.

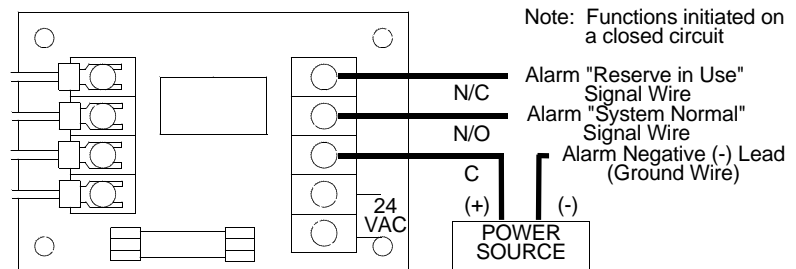

FIGURE 11

3. Connect the positive (+) connection from the power source to the common (C) terminal on the circuit board.
4. Connect the "reserve in use" signal wire to the normally closed (N/C) terminal.
5. If a "system normal" signal is also employed, connect that signal wire to the normally open (N/O) terminal.

WESTERN'S ALARM

1. Connect one 24 VAC lead from the alarm to one 24 VAC terminal on the right side of the circuit board in the power supply box. (Figure 12)
2. Connect the other 24 VAC lead from the alarm to the other 24 VAC terminal.
3. A jumper wire is connected between one 24 VAC terminal and the common (C) terminal.
4. Connect the alarm signal wire to the normally open (N/O) terminal.

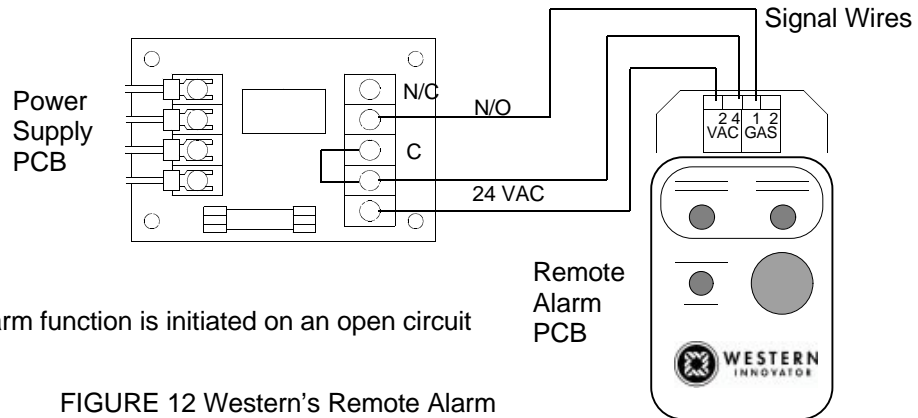

FIGURE 12 Western's Remote Alarm

INSTALLING PIGTAILS AND ATTACHING CYLINDERS

1. Establish flow direction of check valves in pigtails.
2. Connect pigtails to the manifold inlet tee with direction of check valve flow from cylinder to manifold end of pigtail.
3. Attach full cylinders to the pigtail connections as explained in "Cylinder Replacement & Handling" on page 9.
4. S-L-O-W-L-Y turn all cylinders on fully (turn counter-clockwise to open). Check all cylinder and pigtail connections for leaks using Western leak detector LT-100 or an oxygen safe solution. (Any bubbles around connections indicate leakage.)
5. Turn power on to the 24 V power supply transformer box. The red "Replace Depleted Bank" light on the control cabinet should be activated.

START UP AND CHECKING PROCEDURES

1. Turn the control indicator knob fully to the right. S-L-O-W-L-Y open the right cylinder valve (turn counter-clockwise to open). The right bank pressure gauge should show the full pressure of the right bank of cylinders. The green "System Normal" light comes on, extinguishing the red "Replace Depleted Bank" light.
2. S-L-O-W-L-Y open the left cylinder valve fully. The left bank pressure gauge will show the full pressure of the left bank of cylinders.

3. Create a slight flow of gas in the delivery pipeline system. Close the right master valve to simulate a depleting right bank. Observe the following:
 - The right bank gauge pressure slowly falls and the control automatically switches over to the left bank.
 - Delivery pressure remains constant.
 - Green “System Normal” light is extinguished.
 - Red “Replace Depleted Bank” light comes on.
 - Any remote alarms should be activated at this time.
4. S-L-O-W-L-Y reopen the right cylinder valve. Observe the following:
 - Right bank pressure gauge returns to full pressure.
 - Green “System Normal” light comes on.
 - Red “Replace Depleted Bank” light is extinguished.
 - Any remote alarms should be canceled.
5. Turn the control indicator knob fully to the left and repeat procedures 3 and 4 to simulate an empty left bank.

MANIFOLD OPERATION

The manifold control includes the following components and features: green “System Normal”, and red “Replace Depleted Bank” indicator lights, cylinder pressure gauges, line pressure gauges, Inlet relief valves, supply bank control indicator knob, and automatic bank switching. Supply banks consist of a tee with 72" cryogenic flexible pigtailed with check valves.

The cylinder bank that supplies the piping system is known as the “Service” supply, while the cylinders on stand-by are referred to as the “Secondary” supply. Gas flows through the manifold control directly through the line regulator. Delivery pressure is controlled by the line regulator and is adjustable via the access hole in the upper left hand side of the cabinet. (See Delivery Line Adjustment — page 10).

Changeover from the "Service" to "Secondary" side is accomplished by a pressure differential between the inlet and intermediate regulator. As cylinder contents are depleting, pressure passing through the manifold will drop. When this pressure drops to the set pressure of the intermediate regulator, a pressure switch is actuated causing the green “System Normal” light to go out and a red “Replace Depleted Bank” light to come on. The “secondary” bank will automatically begin to flow without any interruption in service line delivery pressure.

There are two definite indicators as to which bank should be changed; (1) the arrow on the control indicator knob in conjunction with the red “Replace Depleted Bank” light and (2) the cylinder bank pressure gauge.

After replacing empty cylinders, open cylinder valves. Because the cylinder pressure will actuate the pressure switch, the red “Replace Depleted Bank” light will be extinguished and the knob indicator must be turned to its opposite position to indicate the new supply bank now in service. Moving the indicator knob to its new position after replacement of an empty bank is the only action that must be taken to reset the manifold. The indicator knob must always be in the extreme right or left position.

To insure proper operation, observe the following guidelines:

1. Carefully follow all instructions.
2. Establish proper flow direction of check valves.
3. Be sure cylinder valves are fully opened.
4. Replace depleted cylinders as soon as practical after the red "replace depleted cylinders" light comes on.

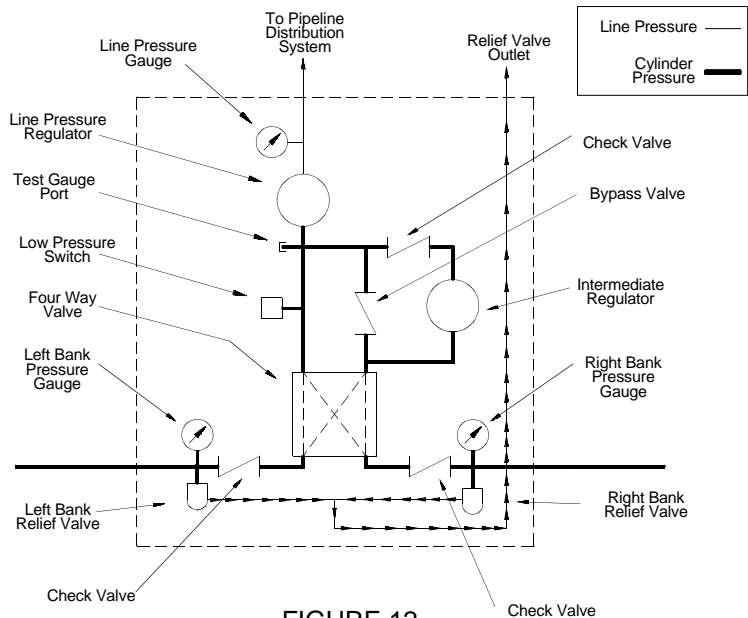

FIGURE 12

CYLINDER REPLACEMENT & HANDLING

1. Shut off all cylinder valves on depleted cylinder bank.
2. S-L-O-W-L-Y loosen and remove the pigtail connection from the depleted cylinders.
3. Remove depleted cylinders and replace protective caps.
4. Remove protective cylinder caps from full replacement cylinders. With the valve outlet pointed away from you or anyone else, slowly open each cylinder valve slightly to blow out any dirt or contaminants which may have become lodged into the cylinder valve.
5. Place and secure full cylinders into position using chains, belts, or cylinder stands.
6. Connect pigtails to cylinder valves and tighten with wrench.
7. S-L-O-W-L-Y turn each cylinder valve until each cylinder is fully on. Check all cylinder and pigtail connections for leaks using Western leak detector LT-100 or an oxygen safe solution (any bubbles around connections indicate leakage).

NOTE: All cylinders shall have their pressure building regulators set at the same pressure.

8. Observe the following conditions:
A red "Replace Depleted Bank" light goes out, and the green "Service Normal" light comes on.
9. Turn the control indicator knob fully to the opposite supply bank to indicate the service bank.

LINE DELIVERY PRESSURE ADJUSTMENT

The delivery line pressure (center gauge) has been factory set. If adjustment is required, carefully proceed according to the following instructions.

1. Leave the manifold in full operational status.
2. Create a flow condition in the delivery pipeline system.
3. Locate the line pressure adjustment access hole on the left side of the manifold control.
4. Adjustment: Using a flat blade screwdriver, turn clockwise to “increase” pressure, turn counterclockwise to “decrease” pressure.
5. Line pressure settings:

	<u>Minimum</u>	/	<u>Maximum</u>
LC Models:	40 psig		85 psig
LCHP Models:	40 psig		180 psig
LCHP-7 Models:	40 psig		210 psig

GENERAL MAINTENANCE

1. Main section
 - a) Daily - record line pressure.
 - b) Monthly
 - 1) Check regulators and valves for external leakage.
 - 2) Check line and intermediate regulators for 'creep'. Repair or replace as necessary.
 - 3) Check valves for closure ability.
 - c) Annually - check relief valve pressures.
2. Manifold header
 - a) Daily - observe nitrous oxide and carbon dioxide systems for cylinder frosting or surface condensation. Should excessive condensation or frosting occur it may be necessary to increase the number of supply cylinders.
 - b) Monthly
 - 1) Inspect valves for proper closure.
 - 2) Check cylinder pigtailed for cleanliness, flexibility, wear, leakage, and thread damage. Replace damaged pigtailed immediately.
 - 3) Inspect pigtail check valves for closure ability.
 - c) Every 4 Years
 - 1) Replace all pigtailed

TROUBLE-SHOOTING

(Only qualified repair personnel should make repairs)

SYMPTOM	PROBABLE CAUSE	REMEDY OR CHECK
ELECTRICAL SYSTEM		
No indicator lights on front panel come on when power is hooked up.	Power Input.	Check electrical power supply.
	Bulb burned out.	Replace bulb or lamp assembly.
Red Indicator light is on but both banks are full.	Cylinder valves on bank are closed.	Slowly open valves.
	Faulty connection to operating alarm unit.	Check input from alarm unit to terminal strip.
	Internal wiring not correct.	Check internal leads to terminal strip.
	Manifold minimum pressure requirements are not being met.	Minimum pressure for LC is 125 psig. Minimum pressure for LCHP is 250 psig.
Red indicator light does not come on when one bank is empty and changeover occurs.	Control knob was rotated to select new "service" side without changing empty cylinders.	Replace depleted cylinders.
	Bulb burned out.	Replace bulb or lamp assembly.
	Pressure switch wiring disconnected.	Check connections
	Pressure switch set too close at too low a pressure.	Adjust pressure switch or return faulty unit for factory setting.
Red indicator light does not come on when one bank is empty. Changeover does not occur.	Control knob was rotated to select new "service" side without changing empty cylinders.	Replace depleted cylinders.
	Faulty connection to operating alarm unit.	Check input from alarm unit to terminal strip.
	Internal wiring incorrect.	Check internal leads to terminal strip.
	Pressure switch set at too low a pressure.	Adjust pressure switch or return faulty unit for factory setting.
Green indicator light does not come on even though both banks are full.	Control knob was rotated to select new "service" side without changing empty cylinders.	Replace depleted cylinders.
	Bulb burned out.	Replace bulb or lamp assembly.
	Pressure switch set at too high a pressure	Adjust pressure switch or return faulty unit for factory setting.

SYMPTOM	PROBABLE CAUSE	REMEDY OR CHECK
LOSS OF RESERVE CONTENTS		
Both banks feeding.	Inlet pressure to manifolds are not correct.	Verify that minimum pressure requirements are met.
	Cylinder venting at cylinder relief valve.	Gas usage not high enough for liquid reserve..
FOUR-WAY VALVE		
Gas leakage around joint in valve body halves.	Body halves not joined tightly enough.	Tighten screws.
	O-rings worn.	Replace valve.
Gas leakage through body wall.	Porosity holes developed in casting.	Replace valve.
Both banks feeding.	Four-way valve seats leaking heavily.	Replace valve.
INTERMEDIATE PRESSURE REGULATOR		
Gas leakage around regulator body/bonnet.	Loose bonnet.	Tighten screws.
Required gas flow not available after change-over occurs.	Intermediate regulator not set correctly.	Adjust intermediate regulator per specifications.
Both banks feeding.	Intermediate regulator set at too high a delivery pressure.	Adjust intermediate regulator per specifications.
	Flow capacity too high.	Reduce flow demand.
LINE PRESSURE REGULATOR		
Gas leakage around regulator body/bonnet.	Loose bonnet.	Tighten screws.
Pipeline not at desired pressure.	Line regulator not set correctly.	Set delivery pressure per specifications.
Required gas flow not available.	Line regulator not set correctly.	Set delivery pressure per specifications.
	Flow capacity too high.	Reduce flow capacity.

MANIFOLD MAINTENANCE & REPAIR PARTS

NOTE:

- Western manifold systems are designed and tested for optimal performance and adherence to safety specifications. We recommend the use of Western replacement components to maintain the standards of performance and safety of the product.

REPLACEMENT PIGTAILS

72" Cryogenic Flexible Pigtales with Check Valves

WMH-2-5	CGA 320 for Carbon Dioxide (CO ₂) Service
WMH-2-6	CGA 326 for Nitrous Oxide (N ₂ O) Service
WMH-2-7	CGA 540 for Oxygen (O ₂) Service
WMH-2-8	CGA 580 for Nitrogen, Argon and Helium Service

INDICATOR LAMP REPLACEMENT PARTS

Square Style

WME-8-42	Replacement Bulb
WME-8-41	Bulb Receptacle
WME-8-40	Red/Green Lens
MK-1010.....	Square Light Repair Kit

PANEL MOUNT GAUGES — 2" Diameter, 1/4" NPT Back Port

WMG-3-2.....	200 psi
WMG-3-4.....	400 psi

REGULATORS AND REGULATOR REPAIR KITS

WMS-3-3	Intermediate Regulator for LC
WMS-3-20	Intermediate Regulator for LCHP
WMR-6-4	Line regulator for LC
WMR-6-6	Line regulator for LCHP
RK-1070	Repair kits for WMS-3-3, WMS-3-20, WMR-6-4, and WMR-6-6

VALVES AND VALVE REPAIR KITS

WMV-5-7	Bypass Check Valve (Economizer)
WMV-5-25-50.....	Bypass Check Valve (Economizer) Oxygen
RK-1041	Repair Kit for Low Pressure Check Valve
WMS-3-2	Four-Way Valve Assembly
WMV-6-4	Pigtail Check Valve

PRESSURE SWITCHES

WME-4-4	Pressure Switch (Argon, CO ₂ , Helium, Nitrogen and N ₂ O)
WME-4-4C.....	Pressure Switch (Oxygen)

POWER SUPPLY REPLACEMENT PARTS

8570D.....	Power Supply Assembly (transformer, PCB, case, and cable)
WME-8-1	Power Supply PCB (includes dry contacts for remote alarms)
9103002	2.5 Amp fuse for in line fuse holder

LIMITED WARRANTY

WARRANTY: The Seller expressly warrants that the products manufactured by it will be free from defects in material, workmanship and title at the date of shipment. This Warranty is exclusive and is IN LIEU OF ALL IMPLIED OR STATUTORY WARRANTIES (INCLUDING WITHOUT LIMITATION, WARRANTIES AS TO MERCHANTABILITY OR FITNESS FOR A PARTICULAR PURPOSE, OR ARISING FROM COURSE OF DEALING OF USAGE OR TRADE) or any other express or implied warranties or representations. All claims under this warranty must be made in writing and delivered to the Seller prior to the expiration of 1 year from the date of shipment from the factory, or be barred. Upon receipt of a timely claim, the Seller shall inspect the item or items claimed to be defective, and Seller shall, at its option, modify, repair, or replace free of charge, any item or items which the Seller determines to have been defective at the time of shipment from the factory, excluding normal wear and tear. Inspection may be performed at the Seller's plant and in such event, freight for returning items to the plant shall be paid by Buyer. Seller shall have no responsibility if such item has been improperly stored, installed, operated, maintained, modified and/or repaired by an organization other than the Seller. Adjustments for products not manufactured by Seller shall be made to the extent of any warranty of the manufacturer or supplier thereof. The foregoing shall be the Seller's sole and exclusive liability and Buyer's sole and exclusive remedy for any breach of warranty or for any other claim based on any defect in, or non-performance of, the products whether based on breach of contract or in tort, including negligence or strict liability.



WESTERN
INNOVATOR

875 Bassett Road
Westlake, Ohio 44145-1142
(800) 783-7890
FAX: (440) 835-8283